

U905 Catalog Section

A note from IDEC:

Due to continuous product improvements, specifications are subject to change without notice.

For up-to-date information, or to request a full copy of this catalog,
please visit us at www.idec.com



Relay Socket Selection Guide

Relay Sockets

| Mounting | Series | Page | Part No. | No. of Poles | Receptacle | Terminal | Compatible IDEC Relay and Timer | |
|--|--|-------|--------------------------------|--------------|------------|--|--|--|
| DIN Rail Snap-Mount  | SR | F-5 | SR2P-05 SR2P-05C SR2P-06 | 2 | 8-Pin | M3.5 Screw | RR2P, RAPP, RBPP, GT5P, RTE-P1, GT3 (8-pin) | |
| | | | SR3P-05 SR3P-05C SR3P-06 | 3 | 11-Pin | | RR3PA, RR2KP, RTE-P2 GT3 (11-pin) | |
| | | | SR3B-05 | 3 | 11-Blade | | RR1BA, RR2BA, RR3B, RTE-B | |
| | SH | F-8 | SH1B-05 SH1B-05C | 1 | 5-Blade | M3.5 Screw Coil Terminal: M3 | RH1B, RAHB, RBHB | |
| | | | SH2B-05 SH2B-05C | 2 | 8-Blade | M3.5 Screw | RH2B, RAMB, RBMB | |
| | | | SH3B-05 SH3B-05C | 3 | 11-Blade | | RH3B, RH2LB | |
| | | | SH4B-05 SH4B-05C | 4 | 14-Blade | | RH4B | |
| | SY | F-12 | SY2S-05 SY2S-05C | 2 | 8-Blade | M3 Screw | RY2S, RY22S | |
| | | | SY4S-05 SY4S-05C | 4 | 14-Blade | | RY4S, RY42S, RY2KS, RY2LS, RM2S, GT5Y | |
| | Panel Mount  | SR | F-14 | SR2P-51 | 2 | 8-Pin | Solder | RR2P, RAPP, RBPP, GT5P, RTE-P1, GT3 (8-pin) |
| | | | | SR3P-51 | 3 | 11-Pin | | RR3PA, RR2KP, RTE-P2, GT3 (11-pin) |
| | | | | SR3B-51 | 3 | 11-Blade | | RR1BA, RR2BA, RR3B |
| SH | | F-15 | SH1B-51 | 1 | 5-Blade | RH1B, RAHB, RBHB | | |
| | | | SH2B-51 | 2 | 8-Blade | RH2B, RAMB, RBMB | | |
| | | | SH3B-51 | 3 | 11-Blade | RH3B, RH2LB | | |
| | | | SH4B-51 | 4 | 14-Blade | RH4B | | |
| SY | | F-17 | SY2S-51 | 2 | 8-Blade | RY2S, RY22S | | |
| | | | SY4S-51 | 4 | 14-Blade | RY4S, RY42S, RY2KS, RY2LS, RM2S, GT5Y | | |
| Surface Mount  | | SH | F-18 | SH2B-02 | 2 | 8-Blade | | M3.5 Screw |
| PCB Mount  | SH | F3-19 | SH1B-62 | 1 | 5-Blade | PC Board | RH1B, RAHB, RBHB | |
| | | | SH2B-62 | 2 | 8-Blade | | RH2B, RAMB, RBMB | |
| | | | SH3B-62 | 3 | 11-Blade | | RH3B, RH2LB | |
| | | | SH4B-62 | 4 | 14-Blade | | RH4B | |
| | SY | F3-20 | SY2S-61 | 2 | 8-Blade | | RY2S, RY22S | |
| | | | SY4S-61 | 4 | 14-Blade | | RY4S, RY42S, RY2KS, RY2LS, RM2S, GT5Y | |
| | | | SY4S-62 | 4 | 14-Blade | RY4S, RY42S, RY2KS, RY2LS, RM2S, GT5Y | | |



For relay mounting accessories, see page F-22.

| | | |
|-----------------------|---------------------------------|---|
| Specifications | Rated Insulation Voltage | 300V; except SH1B and SY4S-62: 250V |
| | Rated Current | SR/SH: 10A, SY: 7A (SH1B coil terminal 7A) |
| | Insulation Resistance | 100MΩ minimum |
| | Dielectric Strength | 2,000V AC, 1 minute |
| | Material Grade | UL94V-0 |

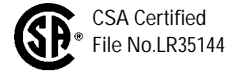

File No. BL950813332307 *



1. * Applicable to DIN rail sockets only.

Relay Socket Part Numbering Guide

Relay socket part numbers are composed of 5 part number codes. When ordering a relay socket, select one code from each category.
Example: SR2P-05C



F

Part Numbers: Relay Sockets

| | Description | Part Number Code | Remarks |
|---------------------|-------------------------------------|------------------|--|
| ① Socket Series | SR | SR | For use with RR series relays |
| | SH | SH | For use with RH series relays |
| | SY | SY | For use with RY series relays |
| ② No. of Poles | 1-pole | 1 | SH series |
| | 2-pole | 2 | SR, SH, and SY series |
| | 3-pole | 3 | SR, and SH series |
| | 4-pole | 4 | SH series |
| ③ Termination | Tubular pin | P | SR series |
| | Blade | B | SH series |
| | Solder/blade | S | SY series |
| ④ Mounting Styles | DIN rail snap-mount | 05 | To decide between configuration 05 and 06, see pictures and schematics beginning on page F-5 Model 05 is available as 05C with a fingersafe option; see ⑤ below |
| | | 06 | |
| | Panel mount | 51 | |
| | PC board mount | 61 | |
| | | 62 | |
| ⑤ Fingersafe Option | With finger-protection terminals | C | Available only on SR, SH, and SY series snap-mount sockets |
| | Without finger-protection terminals | Leave blank | |



2. For hold-down springs and clips for DIN rail snap-mount, panel mount, and PC board mount, see page F-4.
3. For socket accessories, see page F-22.

Hold-Down Springs and Clips Selection Guide

DIN Rail Snap-Mount Sockets

| Socket Part No. | Applicable Relays, Timer | Hold-Down Spring | Hold-Down Clip |
|---------------------|------------------------------|------------------|--------------------|
| SR2P-05 SR2P-05C | RR2P, RAPP, RBPP | SR2B-02F1 | SFA-203 |
| | RTE-P1, GT3, GT5P | — | SFA-203 |
| SR2P-06 | RR2P, RAPP, RBPP | SR2B-02F1 | SFA-202 |
| | GT3 (8-pin), RTE-P1, GT5P | — | SFA-202 |
| SR3P-05 SR3P-05C | RR3PA | SR3B-02F1 | SFA-203 |
| | RR2KP | SR3P-06F3 | SFA-203 |
| | RTE-P2, GT3 (11-pin) | — | SFA-203 |
| SR3P-06 | RR3PA | SR3B-02F1 | SFA-202 |
| | RR2KP | SR3P-06F3 | SFA-202 |
| | RTE-P2, GT3 (11-pin) | — | SFA-202 |
| SR3B-05 | RR1BA, RR2BA, RR3B, RTE-B | SR3B-02F1 | SFA-202 |
| SH1B-05 SH1B-05C | RH1B, RAHB, RBHB | SY2S-02F1 | SFA-101 SFA-202 |
| SH2B-05 SH2B-05C | RH2B, RAMB, RBMB | SY4S-02F1 | SFA-101 SFA-202 |
| SH3B-05 SH3B-05C | RH3B, RH2LB | SH3B-05F1 | SFA-101 SFA-202 |
| SH4B-05 SH4B-05C | RH4B | SH4B-02F1 | SFA-101 SFA-202 |
| SY2S-05 SY2S-05C | RY2S, RY22S | SY2S-02F1 | SFA-101 SFA-202 |
| SY4S-05 SY4S-05C | RY4S, RY42S, RY2LS, RM2S | SY4S-51F1 | SFA-101 SFA-202 |
| | RY2KS, GT5Y | (SY4S-51F3) | SFA-202 |

Panel and PC Board Mount Sockets

| Socket Part No. | Applicable Relays, Timer | Hold-Down Spring | Hold-Down Clip |
|--------------------|------------------------------|--------------------------|--------------------|
| SR2P-51 | RR2P, RAPP, RBPP | SR3P-01F1 | — |
| | GT3 (8-pin), RTE-P1 | — | SFA-402 |
| SR3P-51 | RR3PA | SR3P-01F1 | — |
| | RR2KP | SR3P-51F3 | — |
| | GT3 (11-pin), RTE-P2 | — | SFA-402 |
| SR3B-51 | RR1BA, RR2BA, RR3B, RTE-B | SR3B-02F1 | — |
| SH1B-51 SH1B-62 | RH1B, RAHB, RBHB | SY4S-51F1 | SFA-301 SFA-302 |
| SH2B-51 | RH2B, RAMB, RBMB | SY4S-51F1 (SY4S-02F1) | SFA-301 SFA-302 |
| SH2B-62 | RH2B, RAMB, RBMB | SY4S-51F1 (SY4S-02F1) | — |
| SH3B-51 SH3B-62 | RH3B, RH2LB | SY4S-51F1 (SY4S-02F1) | SFA-301 SFA-302 |
| SH4B-51 SH4B-62 | RH4B | SY4S-51F1 (SY4S-02F1) | SFA-301 SFA-302 |
| SY2S-51 SY2S-61 | RY2S, RY22S | SY4S-51F1 | SFA-301 SFA-302 |
| SY4S-51 SY4S-61 | RY4S, RY42S, RY2LS | SY4S-51F1 (SY4S-02F1) | SFA-301 SFA-302 |
| | RY2KS | SY4S-51F1 (SY4S-02F3) | SFA-302 |
| | GT5Y | — | SFA-302 |
| SY4S-62 * | RY4S, RY42S, RY2LS, RM2S | SY4S-51F1 (SY4S-02F1) | — |
| | RY2KS | SY4S-51F1 (SY4S-02F3) | — |

* Does not accept hold down clips

F

- When mounting relays with a check button onto panel mount or PC board mount sockets, use the hold-down spring shown in parenthesis. Hold-down springs for relays with check buttons are not available for SR2P-51.
- For close mounting of panel mount or PC mount sockets, use hold-down clips rather than hold-down springs.



SFA-101



SFA-202



SFA-302



SFA-402



SR3P-01F1



SY4S-51F1

SR Series: DIN Rail Snap-Mount Sockets

SR2P Sockets



SR2P-05

| | |
|--------------------------|---------------------------------------|
| Style | 8-pin octal, snap-mount/surface mount |
| Terminal | M3.5 screws with captive wire clamp |
| Wire Size | Maximum up to 2-#12AWG |
| Electrical Rating | 300V, 10A |
| Compatible Relay | RR2P, RAPP, RBPP |
| Compatible Timer | RTE-P1, GT3 (8-pin), GT5P |
| Hold-Down Spring | SR2B-02F1 |
| Hold-Down Clip | SFA-203 |

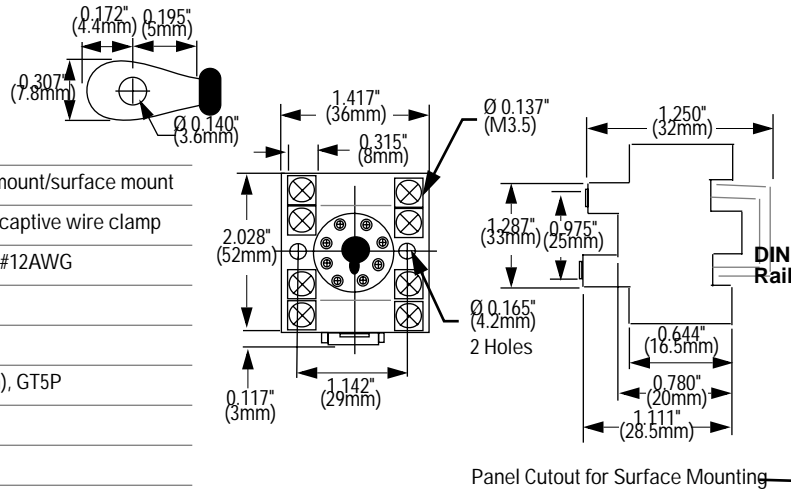

Terminal Arrangements (top view)

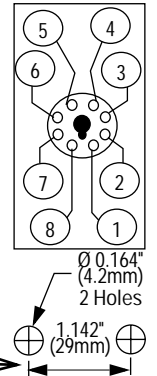

SR2P-05C Fingersafe

| | |
|--------------------------|---|
| Style | 8-pin octal, snap-mount/surface mount |
| Terminal | M3.5 screws with captive wire clamp, fingersafe |
| Wire Size | Maximum up to 2-#12AWG |
| Electrical Rating | 300V, 10A |
| Compatible Relay | RR2P, RAPP, RBPP |
| Compatible Timer | RTE-P1, GT3 (8-pin), GT5P |
| Hold-Down Spring | SR2B-02F1 |
| Hold-Down Clip | SFA-203 |

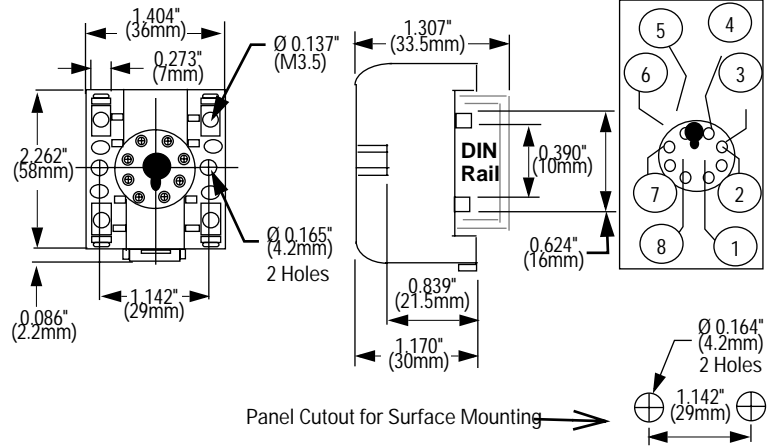

SR2P-06

| | |
|--------------------------|---------------------------------------|
| Style | 8-pin octal, snap-mount/surface mount |
| Terminal | M3.5 screws with captive wire clamp |
| Wire Size | Maximum up to 2-#12AWG |
| Electrical Rating | 300V, 10A |
| Compatible Relay | RR2P, RAPP, RBPP |
| Compatible Timer | RTE-P1, GT3 (8-pin), GT5P |
| Hold-Down Spring | SR2B-02F1 |
| Hold-Down Clip | SFA-202 |

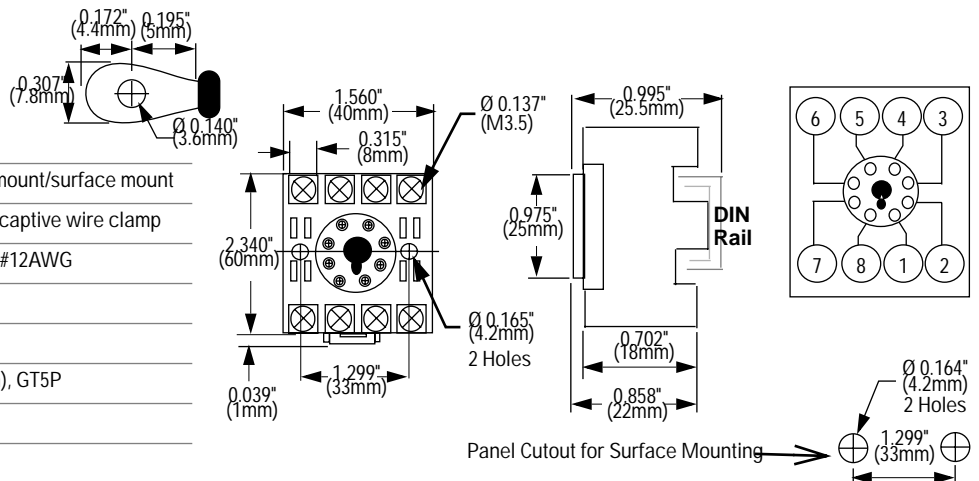

1. For socket mounting accessories, see page F-22.
2. For hold-down clip/spring selections, see page F-4.

SR3P Sockets



| | |
|--------------------------|--|
| SR3P-05 | |
| Style | 11-pin octal, snap-mount/surface mount |
| Terminal | M3.5 screws with captive wire clamp |
| Wire Size | Maximum up to 2-#12AWG |
| Electrical Rating | 300V, 10A |
| Compatible Relay | RR3PA, *RR2KP (*latching relay) |
| Compatible Timer | GT3 (11-pin), RTE-P2 |
| Hold-Down Spring | SR3B-02F1, *SR3P-06F3 (*RR2KP relay) |
| Hold-Down Clip | SFA-203 |

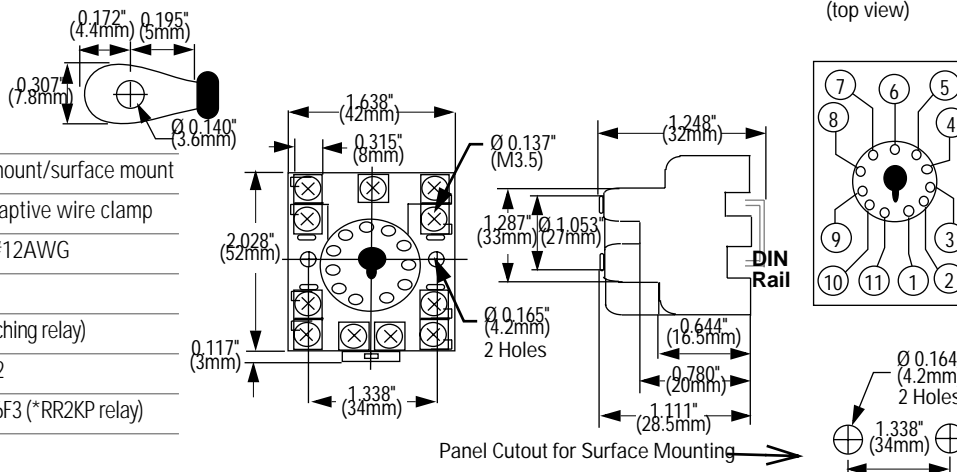

Terminal Arrangements
(top view)

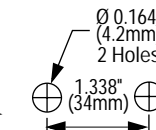
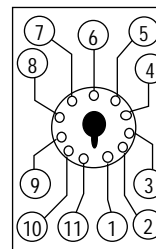

F

| | |
|----------------------------|---|
| SR3P-05C Fingersafe | |
| Style | 11-pin octal, snap-mount/surface mount |
| Terminal | M3.5 screws with captive wire clamp, fingersafe |
| Wire Size | Maximum up to 2-#12AWG |
| Electrical Rating | 300V, 10A |
| Compatible Relay | RR3PA, *RR2KP (*latching relay) |
| Compatible Timer | GT3 (11-pin), RTE-P2 |
| Hold-Down Spring | SR3B-02F1, *SR3P-06F3 (*RR2KP relay) |
| Hold-Down Clip | SFA-203 |

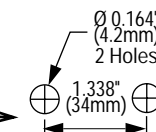
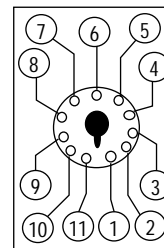
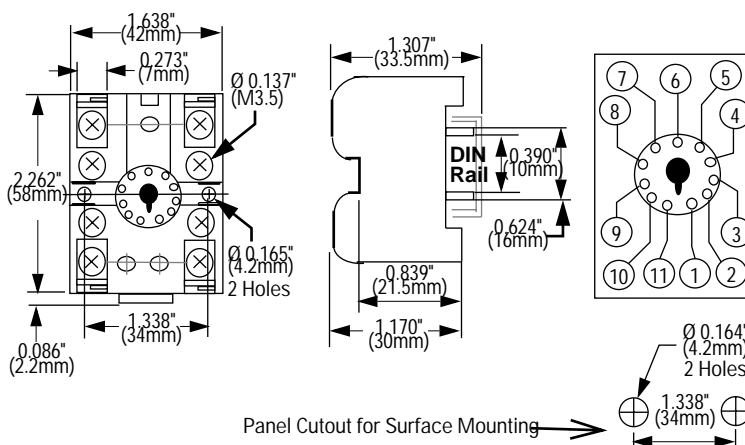

| | |
|--------------------------|--|
| SR3P-06 | |
| Style | 11-pin octal, snap-mount/surface mount |
| Terminal | M3.5 screws with captive wire clamp |
| Wire Size | Maximum up to 2-#12AWG |
| Electrical Rating | 300V, 10A |
| Compatible Relay | RR3PA, *RR2KP (*latching relay) |
| Compatible Timer | GT3 (11-pin), RTE-P2 |
| Hold-Down Spring | SR3B-02F1, *SR3P-06F3 (*RR2KP relay) |
| Hold-Down Clip | SFA-202 |

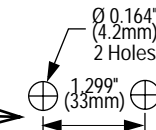
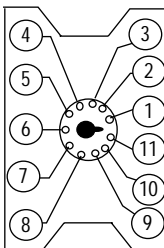
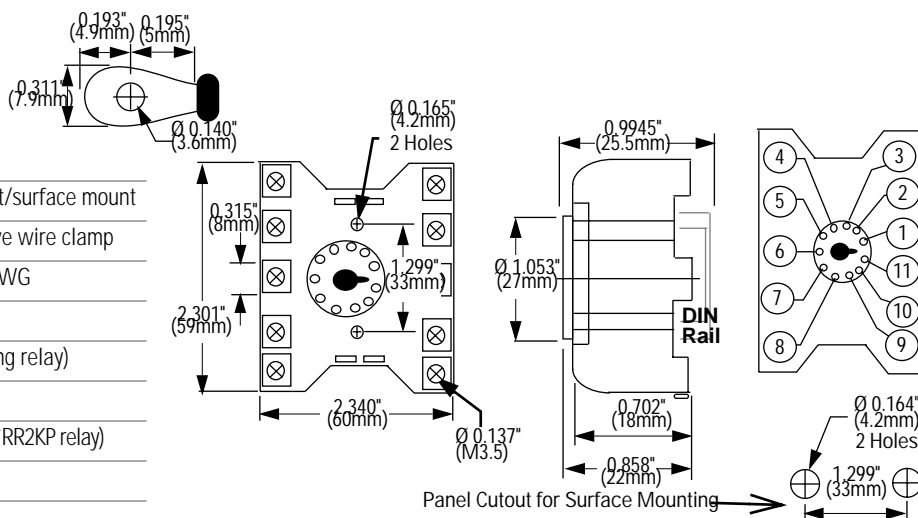

1. For socket mounting accessories, see page F-22.
2. For hold-down clip/spring selections, see page F-4.

SR3B Sockets

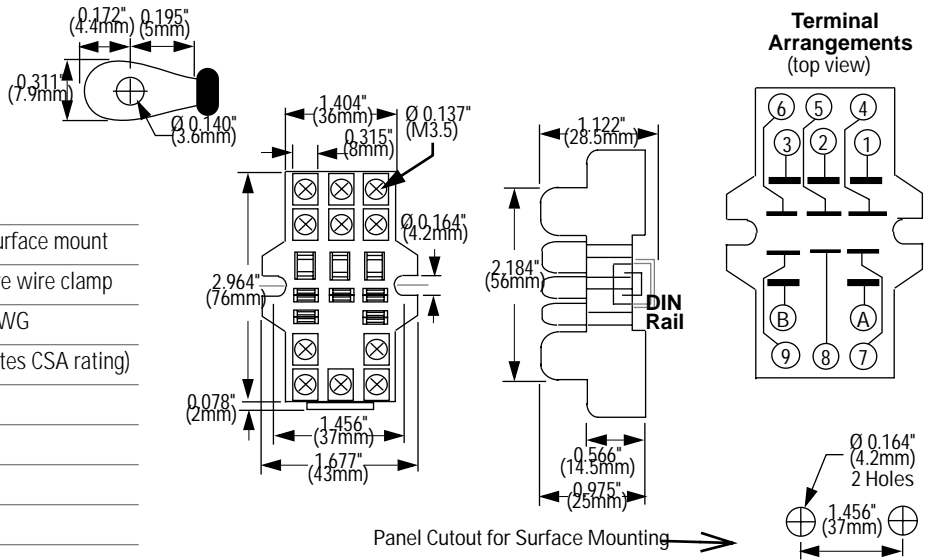

SR3B-05

| | |
|--------------------------|--|
| Style | 11-blade, snap-mount/surface mount |
| Terminal | M3.5 screws with captive wire clamp |
| Wire Size | Maximum up to 2-#12AWG |
| Electrical Rating | 300V, 15A (10A)* (*denotes CSA rating) |
| Compatible Relay | RR1BA, RR2BA, RR3B |
| Compatible Timer | RTE-B |
| Hold-Down Spring | SR3B-02F1 |
| Hold-Down Clip | SFA-202 |



1. For socket mounting accessories, see page F-22.
2. For hold-down clip/spring selections, see page F-4.

SH Series: DIN Rail Snap-Mount Sockets

SH1B Sockets

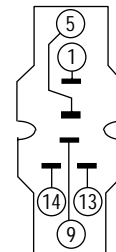
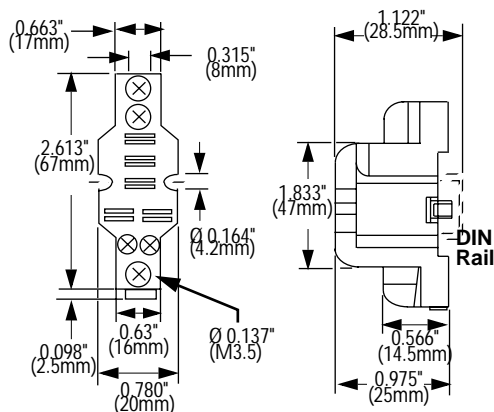
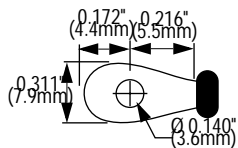

SH1B-05

| | |
|--------------------------|--|
| Style | 5-blade, snap-mount/surface mount |
| Terminal | (Coil) M3 screws/(contact) M3.5 screws with captive wire clamp |
| Wire Size | Maximum up to 2-#12AWG |
| Electrical Rating | 250V, 10A |
| Compatible Relay | RH1B, RAHB, RBHB |
| Hold-Down Spring | SY2S-02F1 |
| Hold-Down Clip | SFA-101, SFA-202 |

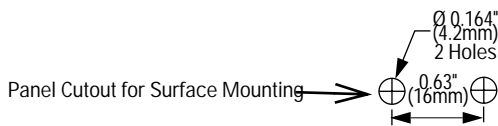

F



SH1B-05C Fingersafe

| | |
|--------------------------|--|
| Style | 5-blade, snap-mount/surface mount |
| Terminal | (Coil) M3 screws/(contact) M3.5 screws with captive wire clamp, fingersafe |
| Wire Size | Maximum up to 2-#12AWG |
| Electrical Rating | 250V, 10A |
| Compatible Relay | RH1B, RAHB, RBHB |
| Hold-Down Spring | SY2S-02F1 |
| Hold-Down Clip | SFA-101, SFA-202 |

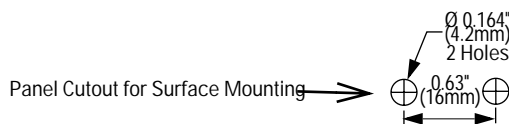
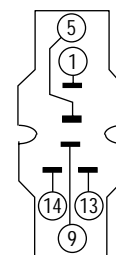
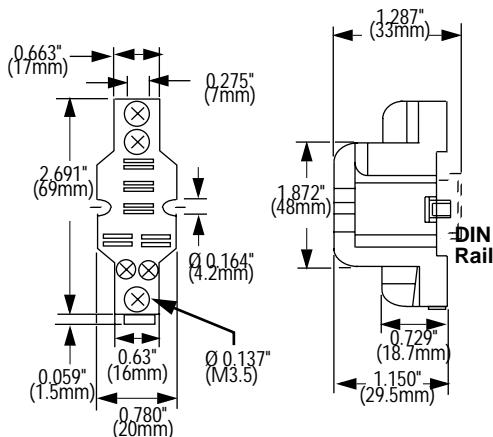

1. For socket mounting accessories, see page F-22.
2. For hold-down clip/spring selections, see page F-4.

SH2B Sockets



SH2B-05

| | |
|--------------------------|-------------------------------------|
| Style | 8-blade, snap-mount/surface mount |
| Terminal | M3.5 screws with captive wire clamp |
| Wire Size | Maximum up to 2-#12AWG |
| Electrical Rating | 300V, 10A |
| Compatible Relay | RH2B, RAMB, RBMB |
| Hold-Down Spring | SY4S-02F1 |
| Hold-Down Clip | SFA-101, SFA-202 |

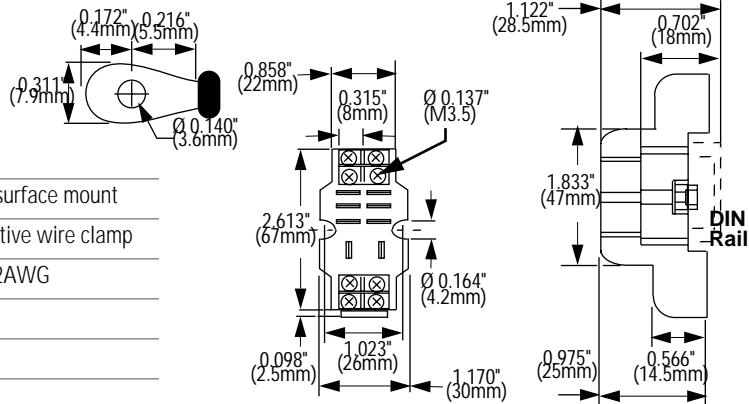

Terminal Arrangements (top view)

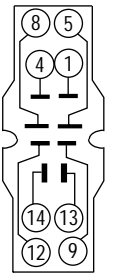

Panel Cutout for Surface Mounting →

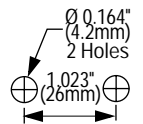

SH2B-05C Fingersafe

| | |
|--------------------------|---|
| Style | 8-blade, snap-mount/surface mount |
| Terminal | M3.5 screws with captive wire clamp, fingersafe |
| Wire Size | Maximum up to 2-#12AWG |
| Electrical Rating | 300V, 10A |
| Compatible Relay | RH2B, RAMB, RBMB |
| Hold-Down Spring | SY4S-02F1 |
| Hold-Down Clip | SFA-101, SFA-202 |

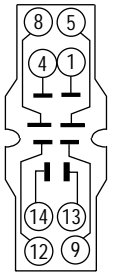
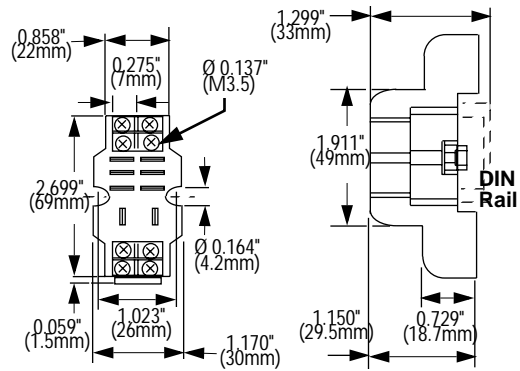

Panel Cutout for Surface Mounting →

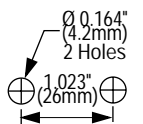

1. For socket mounting accessories, see page F-22.
2. For hold-down clip/spring selections, see page F-4.

SH3B Sockets

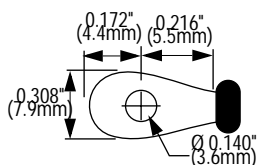

SH3B-05

| | |
|--------------------------|-------------------------------------|
| Style | 11-blade, snap-mount/surface mount |
| Terminal | M3.5 screws with captive wire clamp |
| Wire Size | Maximum up to 2-#12AWG |
| Electrical Rating | 300V, 10A |
| Compatible Relay | RH3B, *RH2LB (*latching relay) |
| Hold-Down Spring | SH3B-05F1 |
| Hold-Down Clip | SFA-101, SFA-202 |

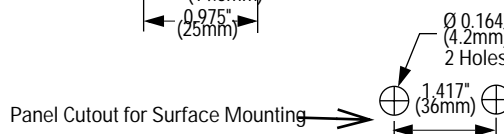
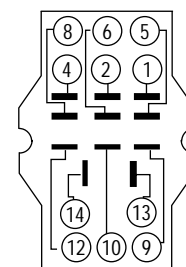
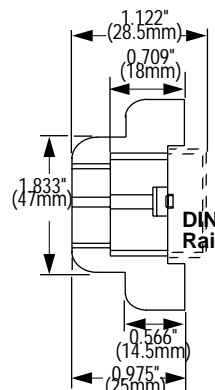
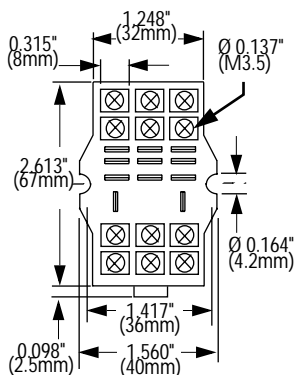

F

SH3B-05C Fingersafe

| | |
|--------------------------|---|
| Style | 11-blade, snap-mount/surface mount |
| Terminal | M3.5 screws with captive wire clamp, fingersafe |
| Wire Size | Maximum up to 2-#12AWG |
| Electrical Rating | 300V, 10A |
| Compatible Relay | RH3B, *RH2LB (*latching relay) |
| Hold-Down Spring | SH3B-05F1 |
| Hold-Down Clip | SFA-101, SFA-202 |

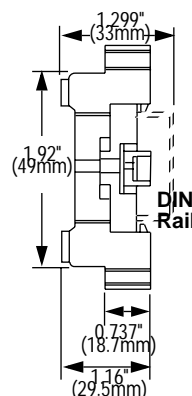
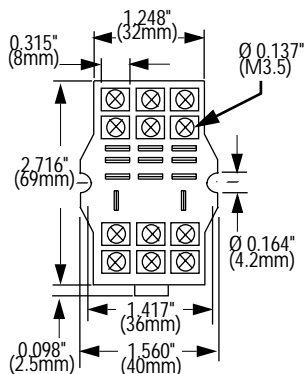

Terminal Arrangements (top view)

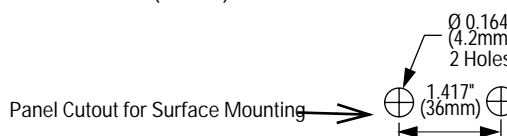
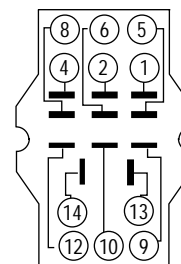

1. For socket mounting accessories, see page F-22.
2. For hold-down clip/spring selections, see page F-4.

SH4B Sockets

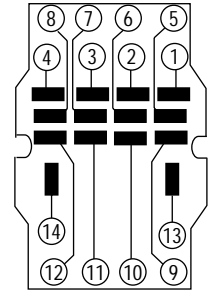
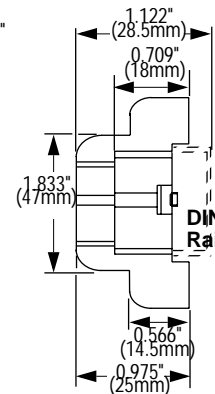
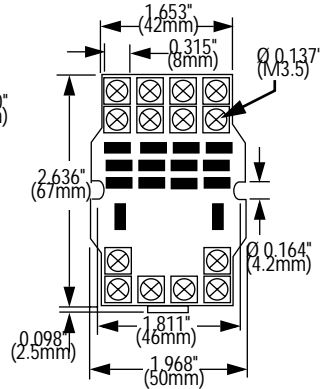
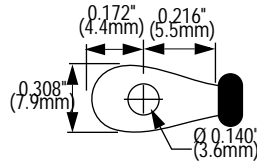

SH4B-05

| | |
|--------------------------|-------------------------------------|
| Style | 14-blade, snap-mount/surface mount |
| Terminal | M3.5 screws with captive wire clamp |
| Wire Size | Maximum up to 2-#12AWG |
| Electrical Rating | 300V, 10A |
| Compatible Relay | RH4B |
| Hold-Down Spring | SH4B-02F1 |
| Hold-Down Clip | SFA-101, SFA-202 |

Panel Cutout for Surface Mounting →

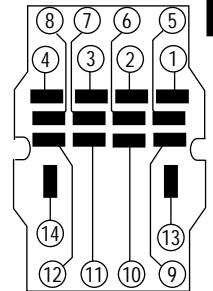
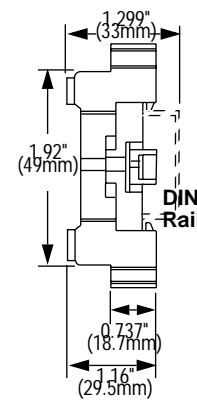
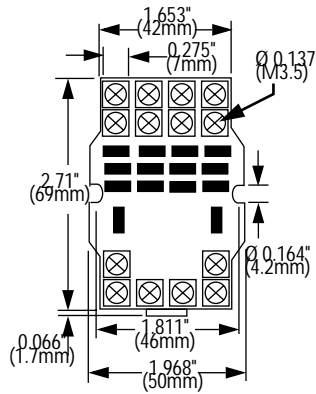
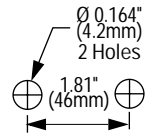

SH4B-05C Fingersafe

| | |
|--------------------------|---|
| Style | 14-blade, snap-mount/surface mount |
| Terminal | M3.5 screws with captive wire clamp, fingersafe |
| Wire Size | Maximum up to 2-#12AWG |
| Electrical Rating | 300V, 10A |
| Compatible Relay | RH4B |
| Hold-Down Spring | SH4B-02F1 |
| Hold-Down Clip | SFA-101, SFA-202 |

Panel Cutout for Surface Mounting →

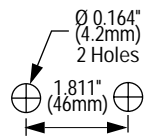

F



1. For socket mounting accessories, see page F-22.
2. For hold-down clip/spring selections, see page F-4.

SY Series: DIN Rail Snap-Mount Sockets

SY2S Sockets

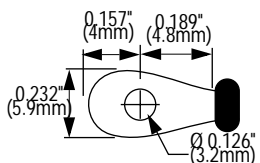

SY2S-05

| | |
|--------------------------|-----------------------------------|
| Style | 8-blade, snap-mount/surface mount |
| Terminal | M3 screws with captive wire clamp |
| Wire Size | Maximum up to 2-#14AWG |
| Electrical Rating | 300V, 7A |
| Compatible Relay | RY2S, RY22S |
| Hold-Down Spring | SY2S-02F1 |
| Hold-Down Clip | SFA-101, SFA-202 |

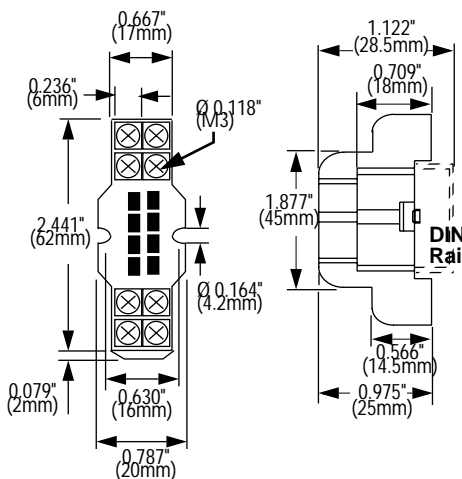

Terminal Arrangements (top view)

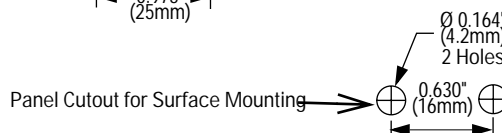
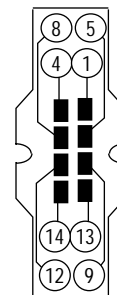

F



SY2S-05C Fingersafe

| | |
|--------------------------|---|
| Style | 8-blade, snap-mount/surface mount |
| Terminal | M3 screws with captive wire clamp, fingersafe |
| Wire Size | Maximum up to 2-#14AWG |
| Electrical Rating | 300V, 7A |
| Compatible Relay | RY2S, RY22S |
| Hold-Down Spring | SY2S-02F1 |
| Hold-Down Clip | SFA-101, SFA-202 |

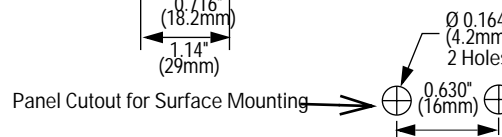
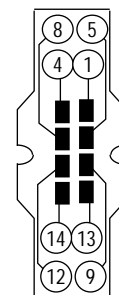
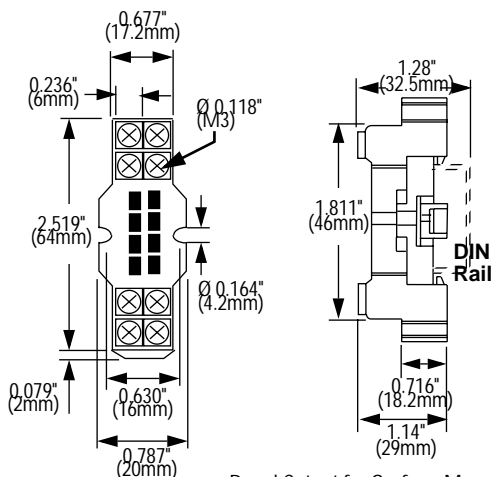

1. For socket mounting accessories, see page F-22.
2. For hold-down clip/spring selections, see page F-4.

SY4S Sockets

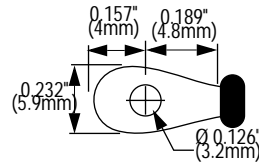

| SY4S-05 | |
|-------------------|--|
| Style | 14-blade, snap-mount/surface mount |
| Terminal | M3 screw with captive wire clamp |
| Wire Size | Maximum up to 2-#14AWG |
| Electrical Rating | 300V, 7A |
| Compatible Relay | RY4S, RY42S, RM2S, *RY2KS, *RY2LS (*latching relays) |
| Compatible Timer | GT5Y |
| Hold-Down Spring | SY4S-51F1, *SY4S-51F3 (*for RY2KS) |
| Hold-Down Clip | SFA-101, SFA-202 |

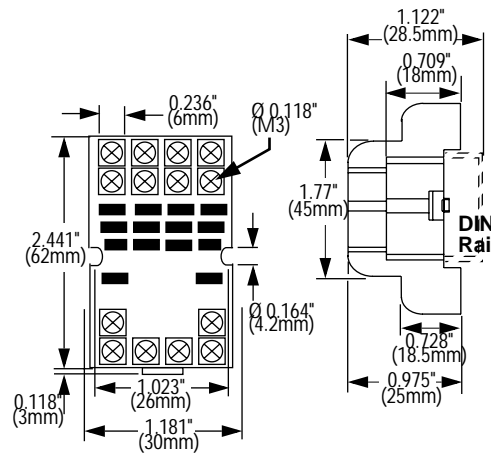

Terminal Arrangements (top view)

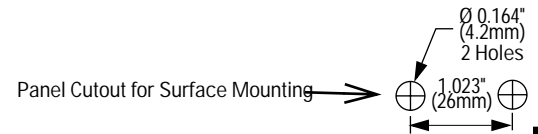
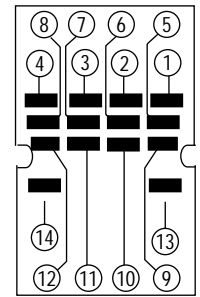

F



| SY4S-05C Fingersafe | |
|---------------------|--|
| Style | 14-blade, snap-mount/surface mount |
| Terminal | M3 screw with captive wire clamp, fingersafe |
| Wire Size | Maximum up to 2-#14AWG |
| Electrical Rating | 300V, 7A |
| Compatible Relay | RY4S, RY42S, RM2S, *RY2KS, *RY2LS (*latching relays) |
| Compatible Timer | GT5Y |
| Hold-Down Spring | SY4S-51F1, *SY4S-51F3 (*for RY2KS) |
| Hold-Down Clip | SFA-101, SFA-202 |

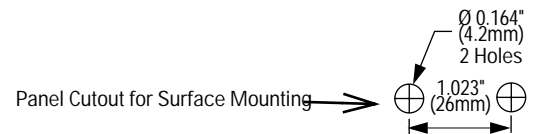
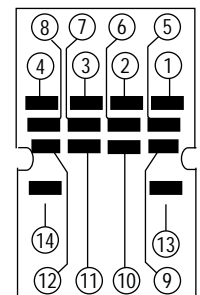
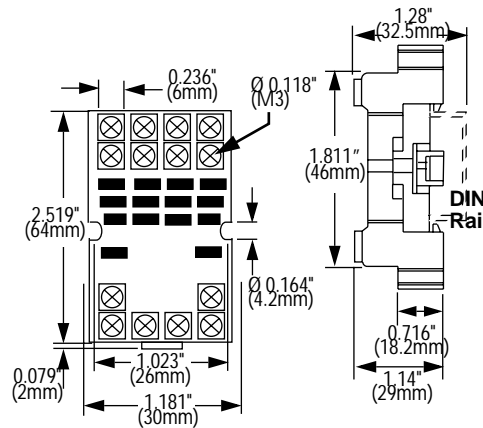

1. For socket mounting accessories, see page F-22.
2. For hold-down clip/spring selections, see page F-4.

SR Series: Panel Mount Sockets



SR3B-51

| | |
|--------------------------|-----------------------|
| Style | 11-blade, panel mount |
| Terminal | Solder |
| Electrical Rating | 300V, 10A |
| Compatible Relay | RR1BA, RR2BA, RR3B |
| Compatible Timer | RTE-B |
| Hold-Down Spring | SR3B-02F1 |

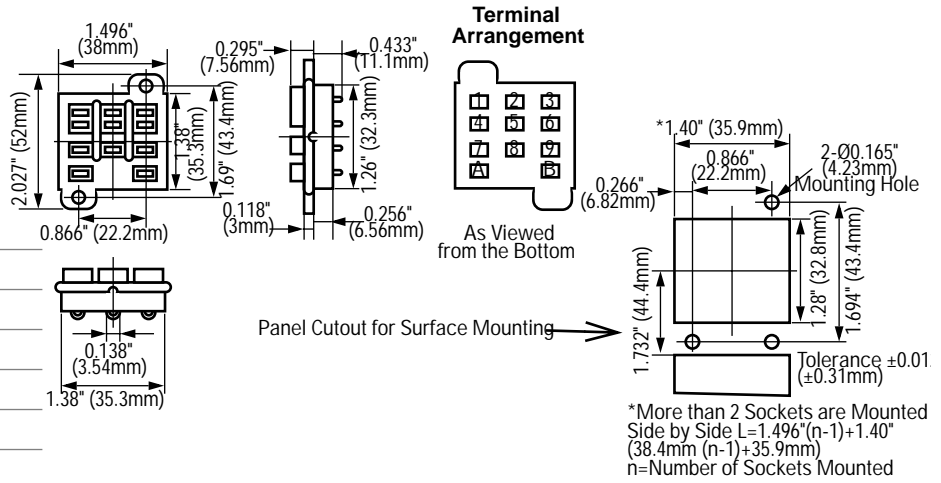

SR2P-51

| | |
|--------------------------|---------------------------|
| Style | 8-pin octal, panel mount |
| Terminal | Solder |
| Electrical Rating | 300V, 10A |
| Compatible Relay | RR2P, RAPP, RBPP |
| Compatible Timer | RTE-P1, GT3 (8-pin), GT5P |
| Hold-Down Spring | SR3P-01F1 |
| Hold-Down Clip | SFA-402 |

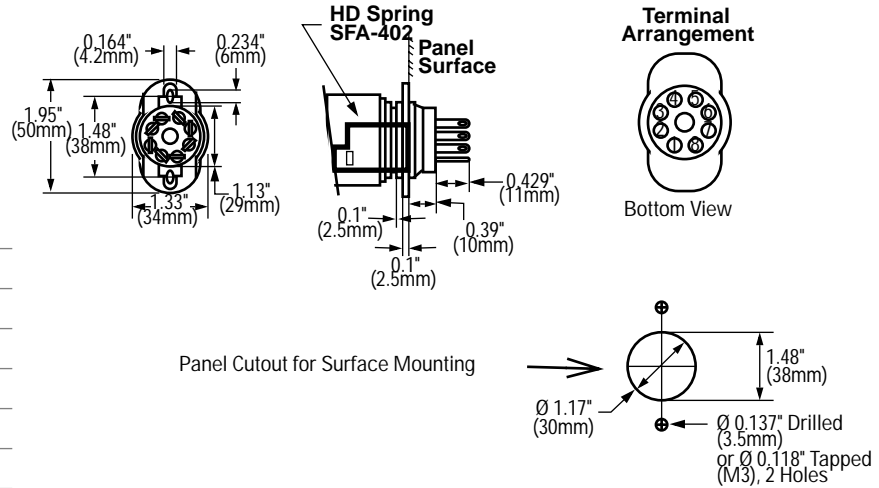

SR3P-51

| | |
|--------------------------|--|
| Style | 11-pin octal, panel mount |
| Terminal | Solder |
| Electrical Rating | 300V, 10A |
| Compatible Relay | RR3PA, *RR2KP (*latching relay) |
| Compatible Timer | GT3 (11-pin), RTE-P2 |
| Hold-Down Spring | SR3P-01F1, *SR3P-51F3 (*for RR2KP relay) |
| Hold-Down Clip | SFA-402 |

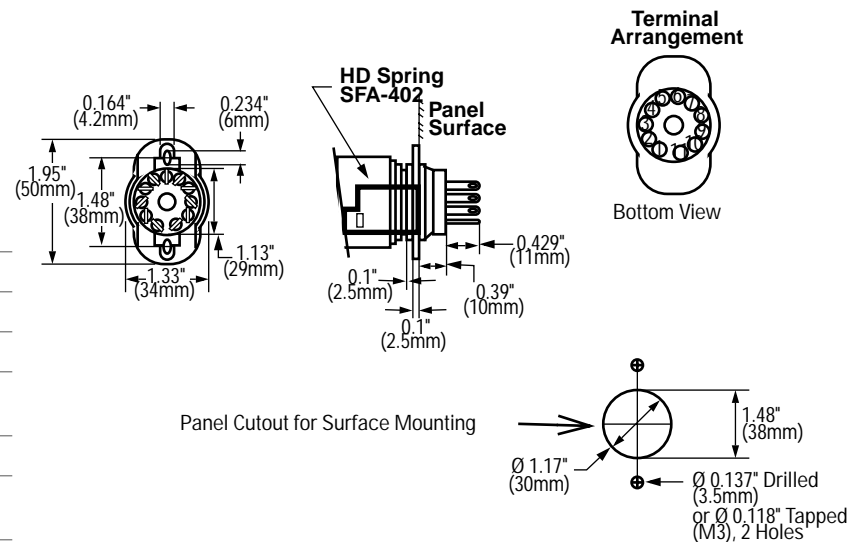

1. For socket mounting accessories, see page F-22.
2. For hold-down clip/spring selections, see page F-4.

SH Series: Panel Mount Sockets



SH1B-51

| | |
|--------------------------|----------------------|
| Style | 5-blade, panel mount |
| Terminal | Solder |
| Electrical Rating | 300V, 10A |
| Compatible Relay | RH1B, RAHB, RBHB |
| Hold-Down Spring | SY4S-51F1 |
| Hold-Down Clip | SFA-301, SFA-302 |

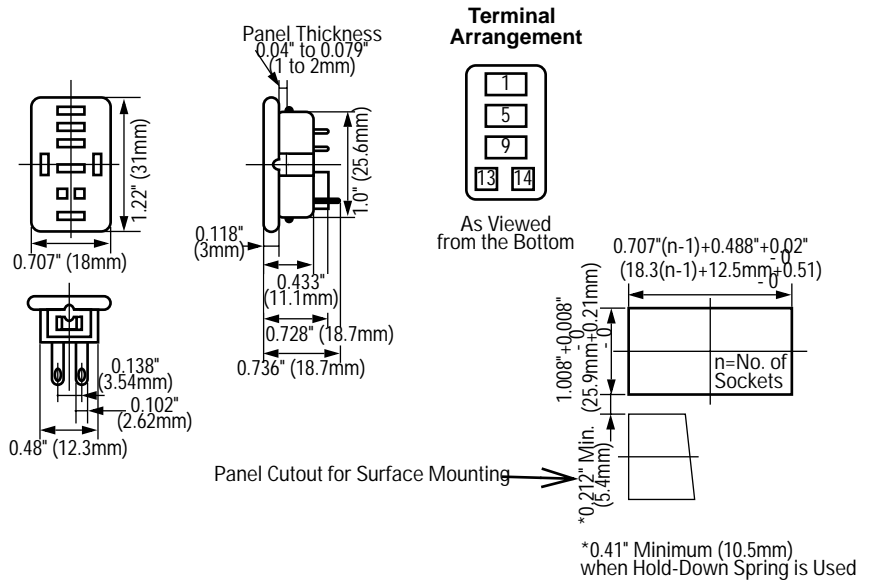

SH2B-51

| | |
|--------------------------|----------------------|
| Style | 8-blade, panel mount |
| Terminal | Solder |
| Electrical Rating | 300V, 10A |
| Compatible Relay | RH2B, RAMB, RBMB |
| Hold-Down Spring | SY4S-51F1, SY4S-02F1 |
| Hold-Down Clip | SFA-301, SFA-302 |

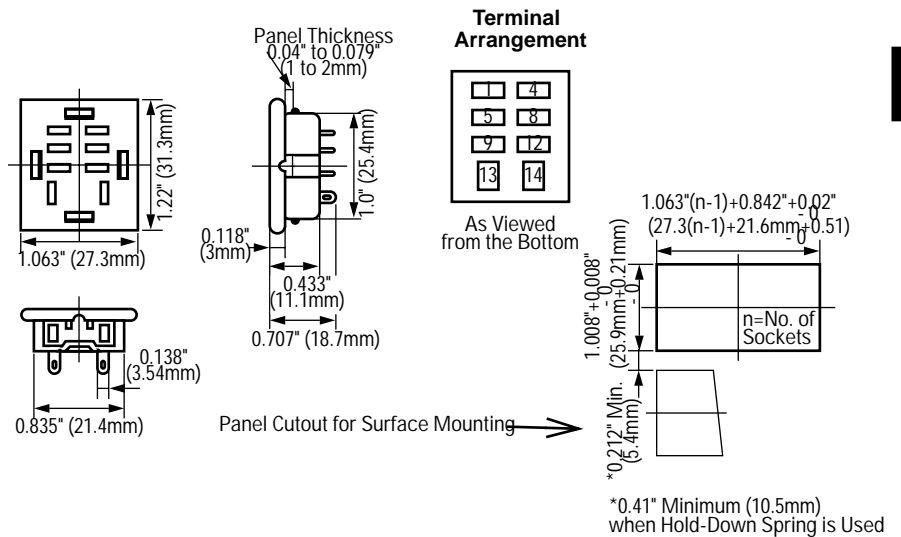

1. For socket mounting accessories, see page F-22.
2. For hold-down clip/spring selections, see page F-4.

SH Series: Panel Mount Sockets, continued



SH3B-51

| | |
|--------------------------|--------------------------------|
| Style | 11-blade, panel mount |
| Terminal | Solder |
| Electrical Rating | 300V, 10A |
| Compatible Relay | RH3B, *RH2LB (*latching relay) |
| Hold-Down Spring | SY4S-51F1, SY4S-02F1 |
| Hold-Down Clip | SFA-301, SFA-302 |

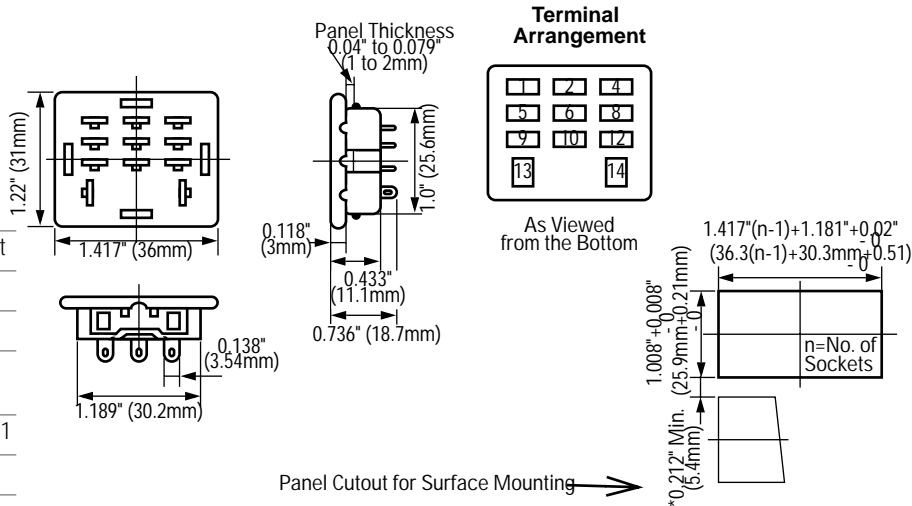

*0.41" Minimum (10.5mm) when Hold-Down Spring is Used

F

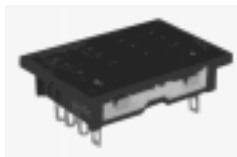

SH4B-51

| | |
|--------------------------|-----------------------|
| Style | 14-blade, panel mount |
| Terminal | Solder |
| Electrical Rating | 300V, 10A |
| Compatible Relay | RH4B |
| Hold-Down Spring | SY4S-51F1, SY4S-02F1 |
| Hold-Down Clip | SFA-301, SFA-302 |

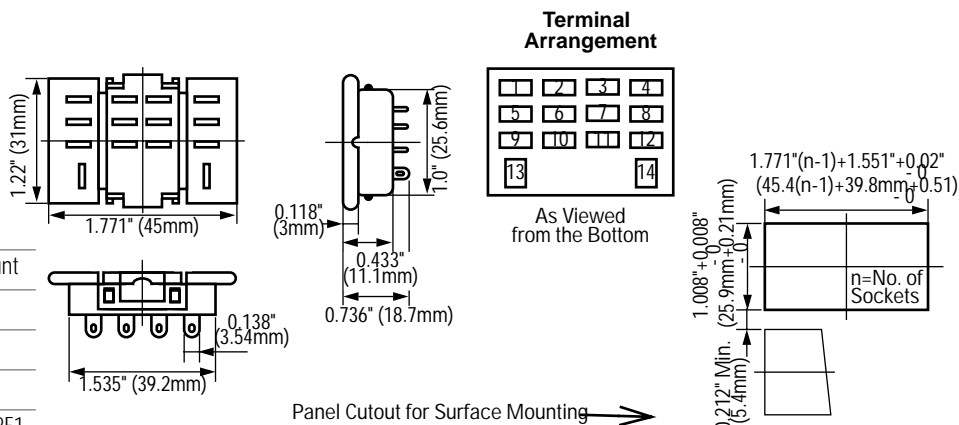

*0.41" Minimum (10.5mm) when Hold-Spring is Used



1. For socket mounting accessories, see page F-22.
2. For hold-down clip/spring selections, see page F-4.

SY Series: Panel Mount Sockets



SY2S-51

| | |
|--------------------------|----------------------|
| Style | 8-blade, panel mount |
| Terminal | Solder |
| Electrical Rating | 300V, 7A |
| Compatible Relay | RY2S, RY22S |
| Hold-Down Spring | SY4S-51F1 |
| Hold-Down Clip | SFA-301, SFA-302 |

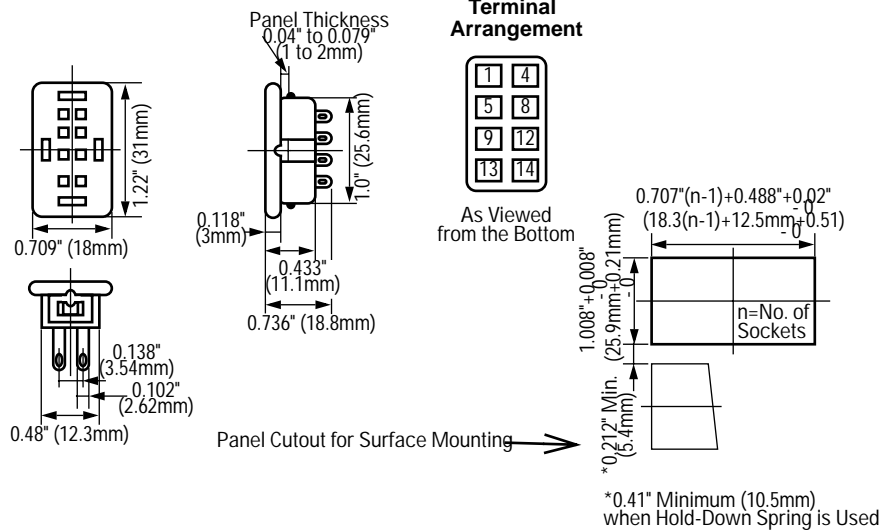

SY4S-51

| | |
|--------------------------|--|
| Style | 14-blade, panel mount |
| Terminal | Solder |
| Electrical Rating | 300V, 7A |
| Compatible Relay | RY4S, RY42S, RM2S, *RY2KS, *RY2LS (*latching relays) |
| Compatible Timer | GT5Y |
| Hold-Down Spring | SY4S-51F1, *SY4S-02F3 (*for RY2KS relay) |
| Hold-Down Clip | SFA-301, SFA-302 |

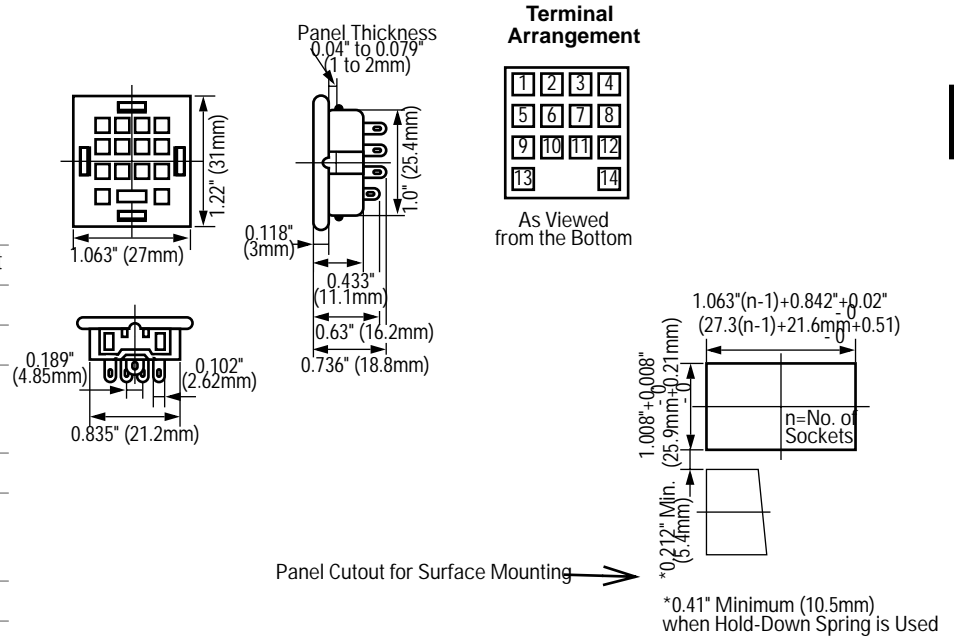

1. For socket mounting accessories, see page F-22.
2. For hold-down clip/spring selections, see page F-4.

SH Series: Surface Mount Sockets



SH2B-02

| | |
|--------------------------|-------------------------------------|
| Style | 8-blade, snap-mount/surface mount |
| Terminal | M3.5 screws with captive wire clamp |
| Electrical Rating | 300V, 10A |
| Wire Size | Maximum up to 2-#12AWG |
| Compatible Relay | RH2B, RAHB, RBHB |
| Hold-Down Spring | SY4S-02F1 |

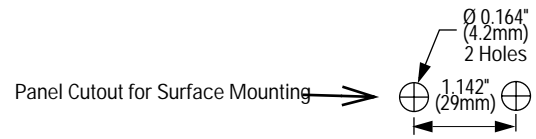
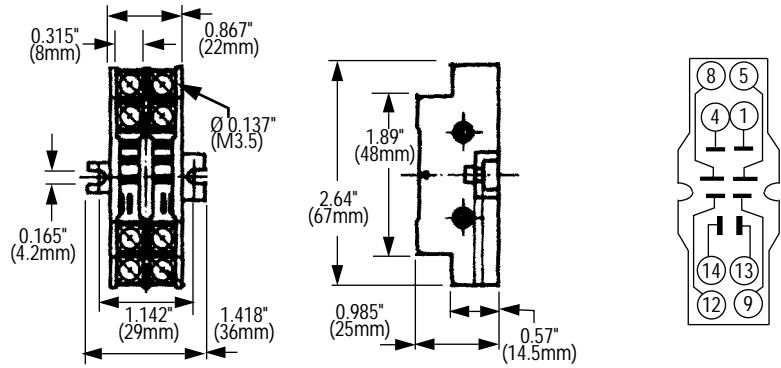

1. For socket mounting accessories, see page F-22.
2. For hold-down clip/spring selections, see page F-4.

SH Series: PC Board Mount Sockets



SH1B-62

| | |
|-------------------|------------------|
| Style | 5-blade |
| Terminal | Solder/PCB mount |
| Electrical Rating | 250V, 10A |
| Compatible Relay | RH1B, RAHB, RBHB |
| Hold-Down Spring | SY4S-51F1 |
| Hold-Down Clip | SFA-301, SFA-302 |

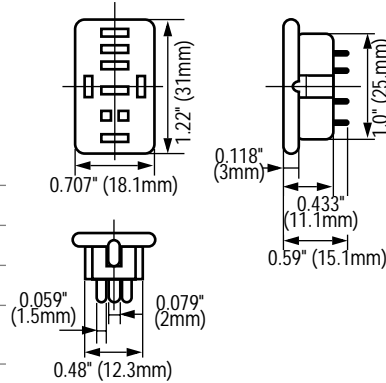

Terminal Arrangement



As Viewed from the Bottom

PCB Layout

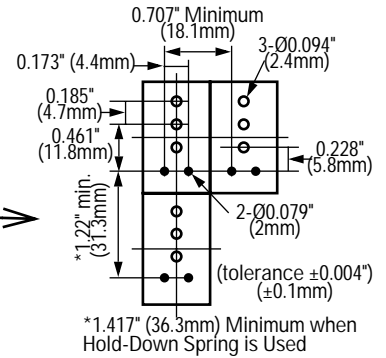

SH2B-62

| | |
|-------------------|----------------------|
| Style | 8-blade |
| Terminal | Solder/PCB mount |
| Electrical Rating | 300V, 10A |
| Compatible Relay | RH2B, RAMB, RBMB |
| Hold-Down Spring | SY4S-51F1, SY4S-02F1 |

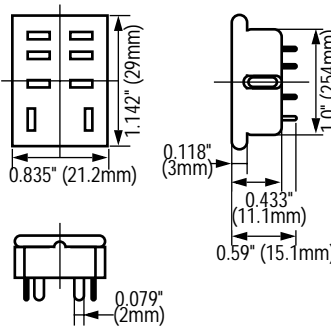

Terminal Arrangement

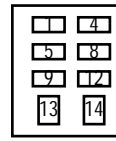

As Viewed from the Bottom

PCB Layout

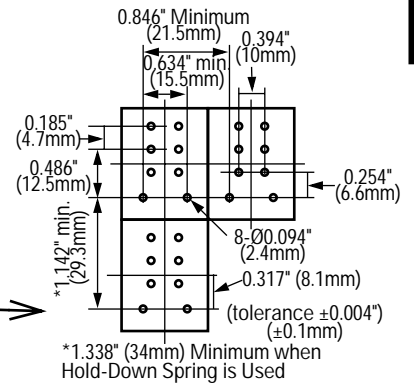

SH3B-62

| | |
|-------------------|--------------------------------|
| Style | 11-blade |
| Terminal | Solder/PCB mount |
| Electrical Rating | 300V, 10A |
| Compatible Relay | RH3B, *RH2LB (*latching relay) |
| Hold-Down Spring | SY4S-51F1, SY4S-02F1 |
| Hold-Down Clip | SFA-301, SFA-302 |

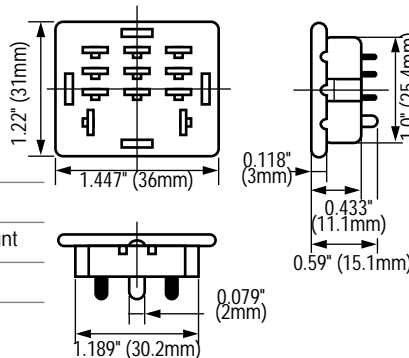

Terminal Arrangement

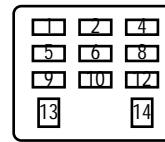

As Viewed from the Bottom

PCB Layout

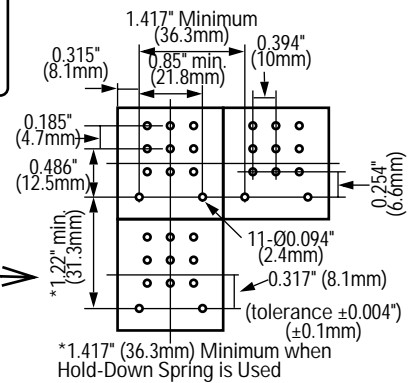

1. For socket mounting accessories, see page F-22.
2. For hold-down clip/spring selections, see page F-4.

SH Series: PC Board Mount Sockets, continued



SH4B-62

| | |
|--------------------------|----------------------|
| Style | 14-blade |
| Terminal | Solder/PCB mount |
| Electrical Rating | 300V, 10A |
| Compatible Relay | RH4B |
| Hold-Down Springs | SY4S-51F1, SY4S-02F1 |
| Hold-Down Clip | SFA-301, SFA-302 |

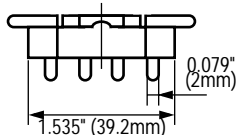
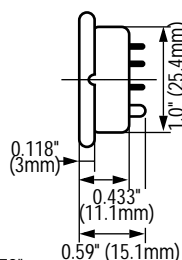
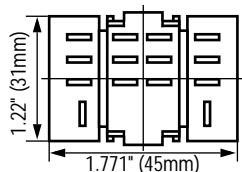

Terminal Arrangement

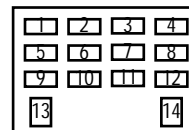

As Viewed from the Bottom

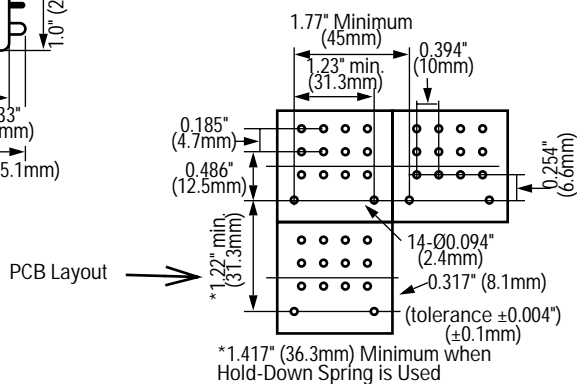

F

SY Series: PC Board Mount Sockets



SY2S-61

| | |
|--------------------------|------------------|
| Style | 8-blade |
| Terminal | Solder/PCB mount |
| Electrical Rating | 300V, 7A |
| Compatible Relay | RY2S, RY22S |
| Hold-Down Spring | SY4S-51F1 |
| Hold-Down Clip | SFA-301, SFA-302 |

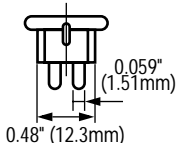
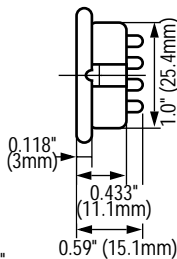
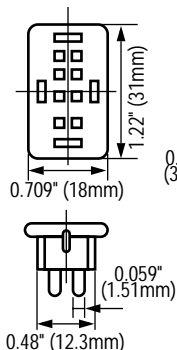

Terminal Arrangement



As Viewed from the Bottom

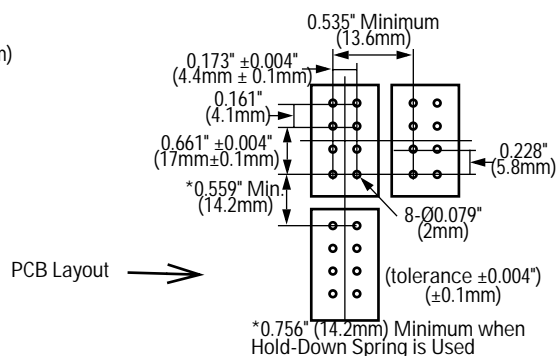

1. For socket mounting accessories, see page F-22.
2. For hold-down clip/spring selections, see page F-4.

SY Series: PC Mount Sockets, continued

SY4S-61

| | |
|--------------------------|--|
| Style | 14-blade |
| Terminal | Solder/PCB mount |
| Electrical Rating | 300V, 7A |
| Compatible Relay | RY4S, RY42S, RM2S, *RY2KS, *RY2LS (*latching relays) |
| Compatible Timer | GT5Y |
| Hold-Down Spring | SY4S-51F1, *SY4S-02F1 (*for RY2KS relay) |
| Hold-Down Clip | SFA-301, SFA-302 |

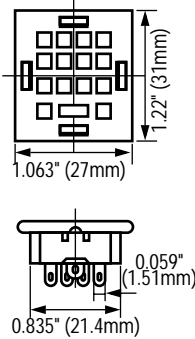
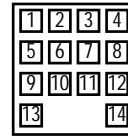
Terminal Arrangement

As Viewed from the Bottom

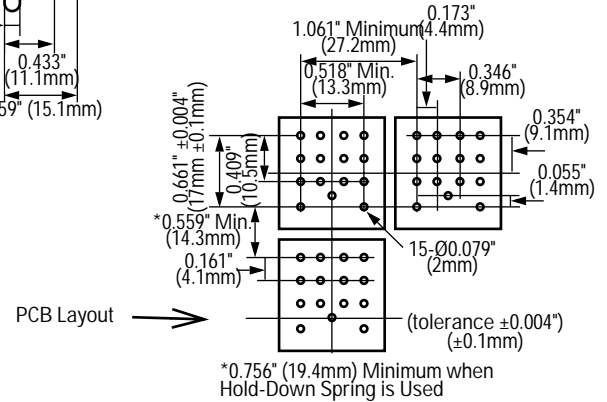
SY4S-62

| | |
|--------------------------|---|
| Style | 14-blade |
| Terminal | Solder/PCB mount |
| Electrical Rating | 250V, 7A |
| Compatible Relay | RY4S, RY42S, RY2LS, RY2KS |
| Compatible Timer | GT5Y |
| Hold-Down Spring | SY4S-51F1, SY4S-51F3, SY4S-51F4, *SY4S-02F1, *SY4S-02F3 (*when mounting a relay with check button) |

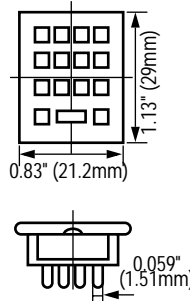
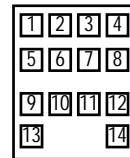

Terminal Arrangement

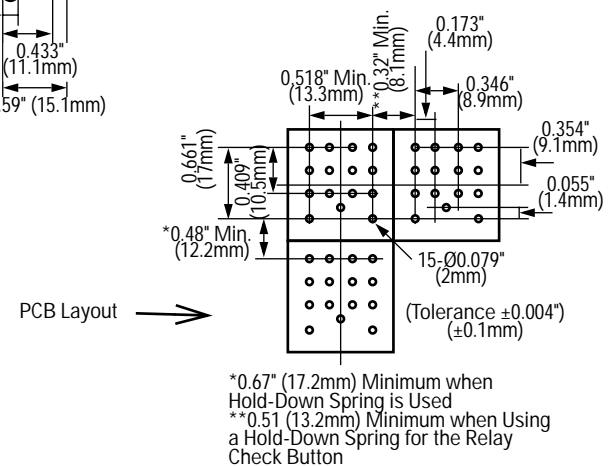
As Viewed from the Bottom

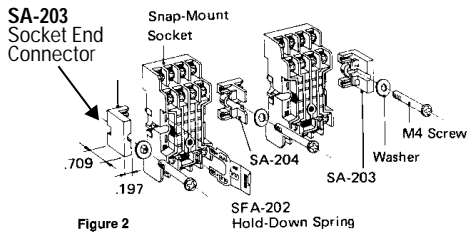

1. For socket mounting accessories, see page F-22.
2. For hold-down clip/spring selections, see page F-4.

Accessories



| Description | Appearance | Use with | Part No. | Remarks |
|---|------------|--|----------|---|
| Aluminum DIN Rail (1 meter length) | | All DIN rail sockets | BNDN1000 | IDEC offers a low-profile DIN rail (BNDN-1000). The BNDN-1000 is designed to accommodate snap-mount sockets and surface mount sockets. Made of durable extruded aluminum, the BNDN-1000 measures 0.413" in height and 1.37" (35mm) in width (DIN standard). Standard length is 39" (1,000mm). |
| DIN Rail End Stop | | BNDN1000 DIN rail | BNL5 | 9.1 mm wide. |
| Surface Mount End Connector | | SY2S, SY4S, SR3B, SH1B, SH2B, SH3B, SH4B | SA-203 | For use on ends of socket groupings when surface mounting. |
| | | | SA-204 | For use between adjoining sockets when surface mounting. |
| Surface Mount Connector | | SY2S, SY4S, SR3B, SH1B, SH2B, SH3B, SH4B | SA-405 | For use between adjoining sockets when surface mounting. |
| DIN Rail Spacer | | All DIN rail sockets | SA-406 | |
| Steel Mounting Plates (for panel mount sockets) | | SY4S-51, SH2B-51 | SA-402 | 11.42" length with 10 holes. |
| | | SY4S-51, SH2B-51 | SA-403 | 23.33" length with 21 holes. |
| Relay Holders | | RH2B, RM2S, RY4S, RY42S, RY2LS, RAMB, RBMB | RH-01 | For diagram, see next page. |
| | | RY2S, RAHB, RBHB, RH1B | RH-03 | |
| Replacement Hold-Down Spring Anchor (horseshoe clip) | | All DIN rail sockets | Y778-011 | For use with hold-down springs (bale wire types) or DIN rail mount sockets. 2 pieces included with each socket. |

F

Instructions

Mounting Snap-Mount Sockets

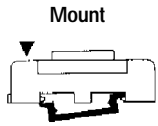

Figure 1

Snap-mount sockets are designed to mount on the BNDN-1000 mounting rail. The built-in mounting clip eliminates mounting hardware and reduces mounting time by 80%.

To mount see Figure 1. Place the end of the socket (end opposite of mounting clip against the outer edge of the rail). Press the socket down firmly until the clip snaps onto the mounting rail. To remove see Figure 2. Pull out the mounting clip with a screwdriver, and lift the socket.

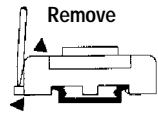
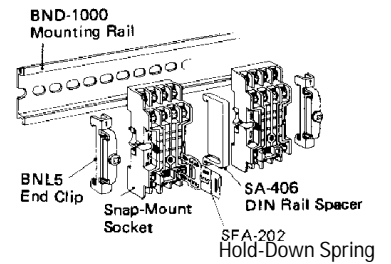

Figure 2

For spacing between adjoining sockets, use the SA-406 DIN rail spacer. Spacers are 0.195" wide. Spacing can be adjusted according to the number of spacers added. Spacers snap on and off easily like snap-mount sockets.

To prevent side-to-side movement, use a BNL-5 end clip at **each** end of every socket row.



Mounting Relay Holders

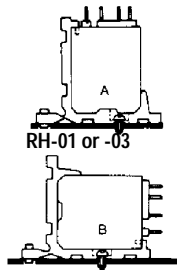

Figure 1

Mount directly onto panel boards in two alternate positions: A and B (see Figure 1).

To mount the relay into the holder, hook the bottom edge of the relay case (coil terminal side) onto the relay holder (see Figure 2).

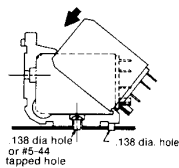

Figure 2

Push down until the relay snaps into place.



Dimensions

Surface Mount Sockets (SH2B-02)

IDEC surface mount sockets (SH2B-02) are also designed to mount individually or collectively on a flat surface without the use of a DIN rail. Use the mounting screw between adjoining sockets and at the outer ends of the row of sockets.

Dimension Table

| Socket Part No. | Dimension A |
|-----------------|-------------|
| SH2B-02 | 1.14" |

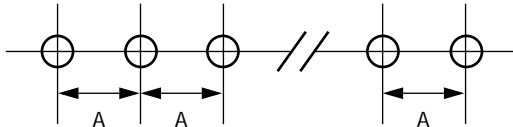

1. Drawing is not to scale.

Snap-Mount Sockets

F Snap-mount sockets are designed to mount individually or collectively without using a rail. Use a SA-405 connector or SA-204 connector between adjoining sockets (see Figures 1 and 2). Use the SA-203 end connector at the outer ends of each socket row when using the SA-204 connector (see Figure 2).

Dimension Table

| Socket Part No. | Dim. B | Dim. C | Dim. D |
|-------------------|--------|--------|--------|
| SY2S-05, SY2S-05C | 0.669" | 0.826" | 0.866" |
| SY4S-05, SY4S-05C | 1.024" | 1.181" | 1.220" |
| SR3B-05 | 1.496" | 1.693" | 1.732" |
| SH1B-05, SH1B-05C | 0.630" | 0.787" | 0.827" |
| SH2B-05, SH2B-05C | 1.024" | 1.181" | 1.220" |
| SH3B-05, SH3B-05C | 1.417" | 1.575" | 1.614" |
| SH4B-05, SH4B-05C | 1.811" | 1.969" | 2.008" |

Using an SA-406 Connector

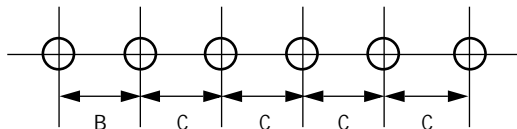

Using SA-203 or SA-204 Connectors

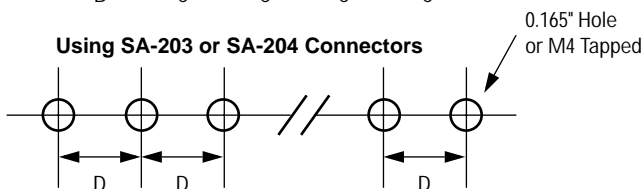

2. Drawings are not to scale.

Dimensions, continued

Collective Panel Mounting

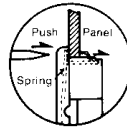
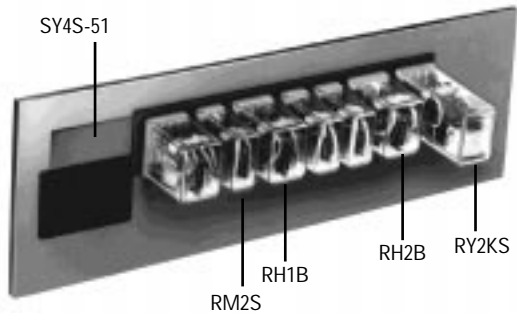

Figure 1

SH and SY series panel mount sockets are designed to mount collectively in panel cut-outs. Insert socket with mounting springs facing the top and bottom edge of the panel cut-out. Push the socket until the mounting spring clips onto the panel. (See Figure 1.)

Dimension Table

| Part No. | Width | Relay |
|----------|--------|--------------------------------|
| SY4S-51 | 1.063" | RY4S, RY42, RY2KS, RY2LS, RM2S |
| SH4B-51 | 1.772" | RH4B |
| SH3B-51 | 1.418" | RH3B, RH2LB |
| SH2B-51 | 1.063" | RH2B, RAMB, RBMB |
| SH1B-51 | 0.709" | RH1B, RAHB, RBHB |
| SY2S-51 | 0.709" | RY2S, RY22S |

How to Calculate Cutout Length (L)

Cutout L = A (Total Overall Width of Each Socket) – 0.221" (+ 0", – 0.020")

Example:

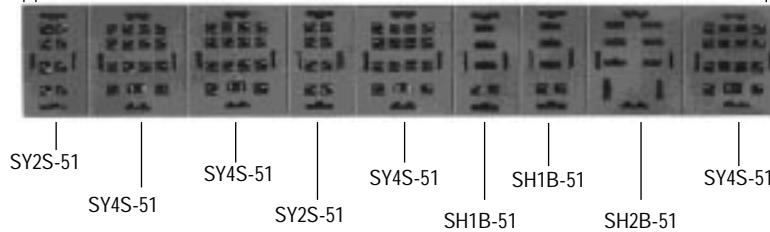
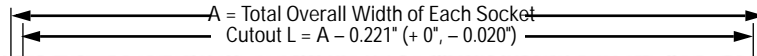

$$L = [0.709" + 1.063" + 1.063" + 0.709" + 1.063" + 0.709" + 1.063" + 1.063"] - 0.221" = 7.93"$$

$$L = 7.93" (+ 0", - 0.020")$$

Mounting Plate

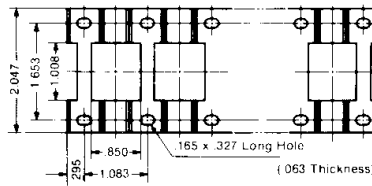

F